



**Title:** n-Controller To i-Controller REV.200 MPU (575V 20-30 Ton) Conversion

## Contents

1. Overview .....	2	8.3 Calibrate Sensors.....	9
2. Contractor Tools & Materials.....	2	8.4 Verify i-Controller Outputs.....	9
3. FLÖ Supplied Parts.....	2	8.5 Dehumidification Test Mode.....	10
4. Install New Power Supply .....	3	8.6 Heating Test Mode.....	10
4.1 Remove Novar Power Supply.....	3	9. BMS Connectivity .....	11
4.2 Install New Transformers.....	3	10. Appendix: .....	12
4.3 Wire New Transformers.....	3	10.1. N-Controller Layout.....	12
4.4 Prepare i-Controller for Installation.....	3	10.2. i-Controller Layout.....	12
4.5 Prepare Expansion Module for Installation .....	3	10.3. Expansion Board Layout .....	12
4.6 Remove Wiring from Novar Power Supply .....	3		
5. Install New Safety Devices & Sensors .....	4		
5.1 Install New CO2 sensor .....	4		
5.2 Install Refrigerant Pressure Transducers .....	4		
5.3 Replace Reheat/Reclaim Surface-Mount Probe	4		
5.4 Install Float Switch .....	5		
5.5 Install Space Temp/RH Combo Sensor.....	5		
6. Install The i-Controller Components.....	6		
6.1 Digital Phase Monitor Input.....	6		
6.2 Remove Existing Novar Controller .....	6		
6.3 Install New i-Controller and Expansion.....	6		
6.4 Install Visograph.....	6		
6.5 Connect the i-Controller to Power.....	6		
6.6 Connect the Expansion Module to Power .....	6		
6.7 Wire Inputs.....	7		
6.8 Wire Analog Output .....	8		
6.9 Wire Relay Output.....	8		
6.10 Connect BACnet Network .....	8		
7. Validate and Power Up the Unit .....	9		
7.1 Check Continuity .....	9		
7.2 Power Up the Unit .....	9		
8. Test Unit Functionality.....	9		
8.1 Set Time and Date.....	9		
8.2 Verify i-Controller Inputs on Visograph .....	9		



# Installation Guide

IN-IC1-11

**Title:**

n-Controller To i-Controller REV.200 MPU (575V 20-30 Ton) Conversion

## 1. Overview

This document describes the steps required to replace the n-Controller with an i-Controller.

Below is a brief summary of an i-Controller upgrade.

- Power supply replacement.
- CO2 sensor replacement.
- Pressure transducer installation.
- Reheat/reclaim inlet sensor replacement.
- Space temp/RH sensor replacement.
- Controller replacement.
- Perform operational tests.

## 2. Contractor Tools & Materials

In addition to a standard toolset, having the items in Table 1 are required during the installation.

ADDITIONAL TOOLS & MATERIALS	
Cordless Drill	Drill Bit Set
Multi-Meter	Adjustable Wrench
Wire Strippers	Wire Crimpers
Temperature Gauge	Psychrometer
Socket Set – Standard	Cell Phone
Red Fork Wire Connectors	Fine Point Sharpie Marker
5/16" Self-Tapping Sheetmetal Screws	
18AWG Stranded Insulated Wire (Red, Black & White)	
Blue, Orange & Yellow Wire Nuts	
Red Insulated Female Spade Connectors	
Micro Control Screwdriver Set (Eye Glass Repair Size)	
Controls Screwdriver	
½" Step Drill Bit for CO2 Sensor Probe Installation	
¼" Refrigerant Tee with Schrader Depressor & 2 Schrader Cores	
4-Conductor Shielded Twisted Wire or Equivalent	
5-Conductor Shielded Twisted Wire or Equivalent	

Table 1. Additional Tools & Materials

## 3. Flō Supplied Parts

The parts contained in the Flō supplied parts kit are provided specifically for the Flō unit at this site.

Contact Flō Technical Support if you have questions or concerns.

Phone: 888-598-1198 Opt. 1

E-Mail: [techsupport@systemsflo.com](mailto:techsupport@systemsflo.com)

Part Description	Part Number	Qty
i-Controller Unit Controller	PTCS8188101	1
i-Controller Expansion Module	PTCS8187001	1
DIN-Rail	PTCSP91730	1
DIN-Rail End Cap	PTCSV66150	2
i-Controller Visograph	PTCS8189002	1
Visograph/CO2 Sensor Mounting Bracket	PTCS184068001	2
24VAC Isolated Transformer	PTCSP47700	2
Fuse Elec 10A/500V MIG	PTCSP63180	2
4-Wire Duct CO2 Sensor (with Tubing and Duct Probe)	PTCSV57760	1
Pressure Transducer (0-500psi)	PTCSV67380	1
Transducer Whip (Blue)	PTCSV42220	1
Pressure Transducer (0-667psi)	PTCSV67390	1
Transducer Whip (Yellow)	PTCSV42100	1
Temperature/Humidity Combo Sensor **	PTCS2035752	1
Reheat/Reclaim Coil Surface Mount Temp Sensor	PTCS5011125	1
Float Switch Kit	PTCSS25801	1
Upgrade Document	IN-IC1-11	1

Table 2. Flō Supplied Parts List

**\*\*NOTE:** PTCS2035752 may be substituted for a RH Sensor (PTCS2035751) and a Temp Probe (PTCS5011121).

**Title:** n-Controller To i-Controller REV.200 MPU (575V 20-30 Ton) Conversion

## 4. Install New Power Supply

**CAUTION:** Make sure the power to the Flō unit is turned off and internal electrical circuits are NOT energized.

### 4.1 Remove Novar Power Supply

Locate and unfasten the Novar power supply board (CT-PS1) from the rear panel of the electrical cabinet, leaving all power supply wiring connected. These wires will be used or removed later in this instruction.

### 4.2 Install New Transformers

Using 5/16" screws, mount the 2 transformers where CT-PS1 was located.

Using the sharpie, mark the transformers as #1 and #2. Transformer 1 will be dedicated to powering the i-controller. Transformer 2 will be dedicated to powering the expansion module.

Install the Flō provided fuses (Fuse Elec 10A/500V MIG) in each of the new transformers.

**NOTE:** No other devices will be connected to these transformers.

### 4.3 Wire New Transformers

Run the new transformers' high voltage wires to Flō high voltage terminals L1 and L2.

**NOTE:** Ensure the transformer tap correlates to the unit's high voltage.

Leave the new transformers' low voltage wires disconnected. These will be terminated in the next steps.

### 4.4 Prepare i-Controller for Installation

Attach 10" lengths of Black 18 AWG wire to the following i-Controller green plug connection points: 1, 7, 8, 25, 28 & 61. See Figure 1. for plug orientation.

Attach 10" lengths of Red 18 AWG wire to the following i-Controller green plug connection points: 9, 15, 16, 29 & 71. See Figure 1. for plug orientation.



Figure 1. Green Connector Reference

Attach Red 18 AWG jumper wires between the following points on the i-Controller green plug connection points: 71 to 80, 80 to 86, and 86 to 90.

Attach a new Black 18 AWG wire between the Flō unit's CSTB1 24 VAC- (grounded side) and the Black 18 AWG wire coming from point 61 on the i-Controller.

Attach a new Red 18 AWG wire between the Flō unit's CSTB1 24 VAC+ (hot side) and the Red 18 AWG wire coming from point 71 on the i-Controller.

### 4.5 Prepare Expansion Module for Installation

Attach 10" length of Black 18 AWG wire to the following Expansion green plug connection points: 1 & 15\*\*.

**\*\*NOTE:** Only pigtail 15 if the unit has a CO2 or outdoor humidity sensor.

Attach a 10" length of Red 18 AWG wire to the following Expansion green plug connection point: 9.

### 4.6 Remove Wiring from Novar Power Supply

Remove the red and black 24 VAC power wires from the CT-PS1 board and connect them to the green 10-pin i-Controller plug. The black wire (-24VAC) terminates to point 28 and the red wire terminates to point 29 (+24VAC).

Remove the yellow wire (24 VDC+) from the CT-PS1 board and attach it to the red wire coming from point 16 on the i-Controller.

**Title:**

n-Controller To i-Controller REV.200 MPU (575V 20-30 Ton) Conversion

Remove the purple wire (5 VDC+) from the CT-PS1 board and attach it to the red wire coming from point 15 on the i-Controller.

Remove the black wire (5 VDC-) from the CT-PS1 board and attach it to the black wire coming from point 8 on the i-Controller.

Discard the CT-PS1 board.

## 5. Install New Safety Devices & Sensors

### 5.1 Install New CO2 sensor

Locate and unfasten the old CO2 sensor. It is located on a column in the store or in the return section of the FLō unit. Cut out and remove the existing 3-conductor wire, from the sensor to the Novar controller points CO2A, CO2B & CO2C. Discard the old CO2 sensor and 3-conductor wire.

Pull a new 4-conductor cable to the return section of the FLō unit. Fasten the new bracket and new sensor to the unit above the outdoor air damper opening on the right-hand side (see figure 3, upper arrow).

Locate the dip switches inside of the new CO2 sensor and change dip switch 1 from 10 VDC to 5 VDC.

Drill a 1/2" hole in the return damper housing and mount the probe (see figure 2, lower arrow).



Figure 2. CO2 sensor location inside the unit

Wire the new CO2 based on the following (see Figure 3.):

- +24VAC – Red wire
- -24VAC – Black wire
- COM – Green wire
- CO2 SIGNAL – White wire

**NOTE:** Do not wire the CO2 sensor to the i-Controller or Expansion Module at this time.

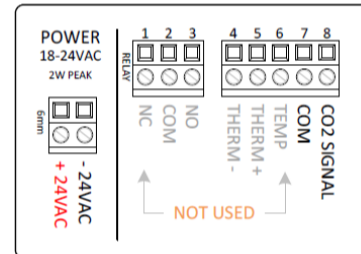

Figure 3. CO2 Sensor Wiring

### 5.2 Install Refrigerant Pressure Transducers

Install the 0-500 Suction PSI transducer on the suction line of circuit B. Install the Discharge 0-667 on the liquid line of circuit B. If there are spare service ports on the unit, install the transducers on a spare service port. If spare service ports are not available, use a refrigerant tee.

Using the provided transducer whips, plug the blue whip into the new suction transducer and the yellow whip into the new discharge transducer. Run the whips back to the i-Controller.

**NOTE:** Do not wire the transducers to the i-Controller or Expansion Module at this time.

### 5.3 Replace Reheat/Reclaim Surface-Mount Probe

Remove the existing Mixed Air Temperature Sensor (MAT-S1) probe and wiring. This is located near the exiting air side of the reheat/reclaim coil. Discard both.

Secure the new temp probe on the inlet piping for the Reheat/Reclaim service of the unit. Run the temp probe sensor wires back to the i-Controller.

**NOTE:** Do not wire the temp probe to the i-Controller at this time.

**Title:**

n-Controller To i-Controller REV.200 MPU (575V 20-30 Ton) Conversion

### 5.4 Install Float Switch

Connect the float switch to the provided bracket using the provided washer and nut.

Mount the provided bracket so that the base of the bracket is roughly 2 inches from the drain pan base and located at the front left corner of the drain pan, on the supply fan wall (see figure 2 for positioning requirements)



Figure 2. Float Switch Mounting Position

Pull a 2-conductor cable to the electrical cabinet.

### 5.5 Install Space Temp/RH Combo Sensor

Replace the current space temp/RH sensors in the space with a new combo sensor (203-5752) or separate RH & Space Temp (203-5751 & 501-1125) provided with this kit.

**NOTE:** If necessary, pull a new 5-wire conductor cable.

Mount the base of the new space temp/RH combo sensor in the place where the old sensor was located.

Wire the new combo sensor based on the following:

- +12VDC – Red wire
- 0V (on Humidity side) – Black wire
- RH OUT (+0-5V) – White wire
- 0V (on Temp side) – Green wire
- SIGNAL – Blue wire

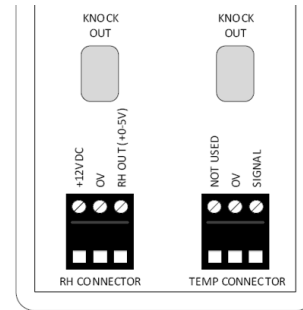

Figure 4.1. 203-5752 Space Temp/Humidity Terminal Connections

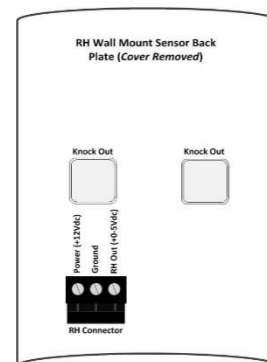

Figure 4.2. 203-5751 Humidity Terminal Connections



Figure 4.3. 501-1125 Temp Sensor Mounting Position In RH

**IMPORTANT:** If you have a 203-5752, move the jumper on JP3 from 10V to 5V on the combo sensor.

**NOTE:** Do not wire the combo sensor to the i-Controller or Expansion Module at this time.

**Title:** n-Controller To i-Controller REV.200 MPU (575V 20-30 Ton) Conversion

## 6. Install The i-Controller Components

### 6.1 Digital Phase Monitor Input

Pull a 2-conductor cable from the DPM to the future i-Controller location in the electrical cabinet. Connect wire at DPM to Auxiliary contact points.

### 6.2 Remove Existing Novar Controller

Locate the n-Controller and remove it from the din rail. Do not remove the control wires on the n-Controller at this time.

### 6.3 Install New i-Controller and Expansion

Mount the i-Controller and expansion modules on DIN rail.

Double-check that the Expansion Module is addressed as 1. Verify the addressing and adjust as necessary according to the switch in *Figure 5*.

Wire the Visograph based on the following:

- White wire VNR (Visograph) → 103 (i-Controller)
- Red wire + (Visograph) → 104 (i-Controller)
- Black wire – (Visograph) → 105 (i-Controller)

### 6.5 Connect the i-Controller to Power

Connect transformer 1's low voltage common to black 10" wire from i-Controller pin 1.

Connect transformer 1's low voltage 24V to red 10" wire from i-Controller pin 9.

### 6.6 Connect the Expansion Module to Power

Connect transformer 2's low voltage common to black 10" wire from expansion pin 1.

Connect transformer 2's low voltage 24V to red 10" wire from expansion pin 9.

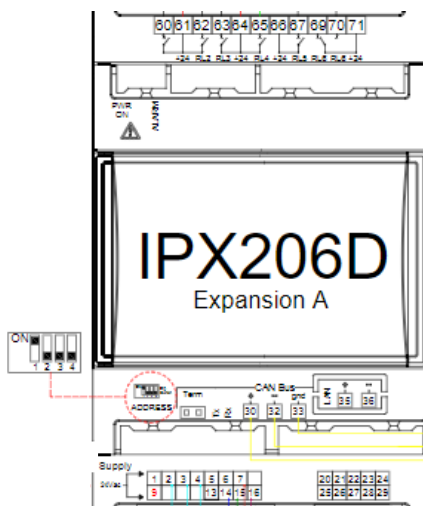

Figure 5. FLÖ i-Controller Expansion A Addressing

Wire the expansion module to the main i-Controller via the **CAN Bus** port based on the following:

- Expansion Module 30 (+) → i-Controller 100 (+)
- Expansion Module 32 (-) → i-Controller 101 (-)
- Expansion Module 33 (gnd) → i-Controller 102 (gnd)

### 6.4 Install Visograph

Mount the Visograph and connect it to the i-Controller port.

**Title:**

n-Controller To i-Controller REV.200 MPU (575V 20-30 Ton) Conversion

### 6.7 Wire Inputs

Wire analog/digital inputs based on table 3.

n-Controller Points	i-Controller	i-Controller Pin #
<b>NEW</b>	24 VAC Transformer Power 1 -	1*
	24 VAC Transformer Power 1 +	9*
	Space Temperature SG	2
	Space Temperature 0V	7*
	Space Humidity SG	3
	Space Humidity 0V	8*
	Space Humidity Power	16*
See Wiring Diagram in Unit	Supply Temperature SG	4
	Supply Temperature 0V	7*
<b>NEW</b>	Reheat/Reclaim Inlet Probe 1 SG	5
	Reheat/Reclaim Inlet Probe 1 0V	7*
See Wiring Diagram in Unit	Outside Air Temperature SG	6
	Outside Air Temperature 0V	7*
	Return Temperature SG	10
	Return Temperature 0V	7*
	Suction Pressure Comp 1 SG	11
	Suction Pressure Comp 1 0V	8*
	Suction Pressure Comp 1 Power	15*
	Discharge Pressure Comp 1 SG	12
	Discharge Pressure Comp 1 0V	8*
Discharge Pressure Comp 1 Power	15*	
<b>NEW</b>	Suction Pressure Comp 2 SG	13
	Suction Pressure Comp 2 0V	8*
	Suction Pressure Comp 2 Power	15*
	Discharge Pressure Comp 2 SG	14
	Discharge Pressure Comp 2 0V	8*
	Discharge Pressure Comp 2 Power	15*

n-Controller Points	i-Controller	i-Controller Pin #
See Wiring Diagram in Unit	Smoke Detector SG	40
	Smoke Detector 0V	61*
	Airflow Switch SG	41
	Airflow Switch 0V	61*
	Clogged Filter SG	42
	Clogged Filter 0V	61*
	Load Shed SG (if equipped)	45
	Load Shed 0V (if equipped)	61*
	<b>NEW</b>	Drain Pan Float Switch SG
Drain Pan Float Switch 0V		61*
Phase Monitor SG		44
Phase Monitor 0V		61*

n-Controller Points	Expansion Module	Expansion Pin #
<b>NEW</b>	24 VAC Transformer Power 2 -	1*
	24 VAC Transformer Power 2 +	9*
	CO2 SG (if equipped)	2
	CO2 0V (if equipped)	15*
	CO2 +24 (if equipped)	CSTB1 Red**
	CO2 -24 (if equipped)	CSTB1 Black**
	See Wiring Diagram in Unit	Outdoor Humidity SG (if equipped)
Outdoor Humidity 0V (if equipped)		15*
Outdoor Humidity Power (if equipped)		7

\*This indicates that you will be attaching to a 10" wire, not a pin.

\*\*This indicates that you will be attaching to the CSTB1.

Table 3. Input Conversion Table

**Title:** n-Controller To i-Controller REV.200 MPU (575V 20-30 Ton) Conversion

## 6.8 Wire Analog Output

Wire analog outputs based on table 4.

n-Controller Point	Analog Output Description	i-Controller Pin #
See Wiring Diagram in Unit	Outside Air Damper SG	21
	Outside Air Damper 0V	25*
	Return Air Damper SG	22
	Return Air Damper 0V	25*
	Bypass Air Damper SG	23
	Bypass Air Damper 0V	25*
	VFD SG	24
	VFD 0V	25*
	Digital Compressor 1 SG	26
	Digital Compressor 1 0V	25*
New	CSTB -24VAC Black	28*
	CSTB +24VAC Red	29*

\*This indicates that you will be attaching to a 10" wire, not a pin.

Table 4. Analog Output Conversion Table

## 6.9 Wire Relay Output

Wire relay outputs based on table 5.

n-Controller Point	Relay Outputs	i-Controller Pin #
See Wiring Diagram in Unit	Supply Fan (NO)	70
	Heat Stage 1 (NO)	72
	Heat Stage 2 (NO)	73
	Heat Stage 3 (NO)	76
	Heat Stage 4 (NO)	77
	Compressor 2 (NO)	78
	Condenser Fan 2 (NO)	79
	Reheat/Heat Reclaim 1 (NO)	84
	CSTB1 +24VAC	71, 80, 86*, 90

**\*WARNING:** For units equipped with refrigerant reclaim, do not wire +24VAC to point 86. The dry common from the refrigeration rack reclaim control is connected to point 86.

Table 5. Digital Output Conversion Table

## 6.10 Connect BACnet Network

Wire BACnet based on the following:

- Black wire RS485 Master – → 94 (i-Controller)
- White wire RS485 Master + → 95 (i-Controller)
- Shield wire RS485 Master GND → 96 (i-Controller)



**Title:**

n-Controller To i-Controller REV.200 MPU (575V 20-30 Ton) Conversion

## 7. Validate and Power Up the Unit

### 7.1 Check Continuity

Once all connections are complete, using a multimeter, verify points 1, 7, and 8 are not reading to earth ground.

Now check for shorts within the analog sensor connections by measuring between points 7 and 8.

If you have any issues, please call FLō tech support at 1-888-598-1198.

### 7.2 Power Up the Unit



Turn on the unit disconnect and wait for the i-Controller screen to display "CES".

## 8. Test Unit Functionality



### 8.1 Set Time and Date

From the **Main Menu**, press **T5**, (**Network Info**).

Press  and verify the time is correct. If the correct time is not displayed, set the time.

Use the   to navigate to the hour or minute fields.

With a field highlighted, press ; the value will begin blinking.

While the highlighted value is blinking, use the   and set the value. Press  a second time to accept changes.

The controller will automatically reboot after the date and or time has been changed.

### 8.2 Verify i-Controller Inputs on Visograph

Verify all installed sensors are present and displaying accurate values.

From the **Main Menu**, press and hold down **T7**. While holding **T7** down, depress **T1**. This key combination unlocks the **Field Technician Options** screen.

Press **T6** to navigate to the IO Status screen. Press **T1** to access the Input Status screen. Press  to view additional pages.

### 8.3 Calibrate Sensors

From the **Main Menu**, press and hold down **T7**. While holding **T7** down, depress **T1** (**Sensor Offsets**).

Press  to view additional pages.

Enter the offset(s) as necessary. Do not exceed  $\pm 3^{\circ}\text{F}$  for a temperature sensor,  $\pm 2^{\circ}\text{F}$  for a dewpoint sensor or  $\pm 3\%$  for a humidity sensor.

### 8.4 Verify i-Controller Outputs

From the **Main Menu**, press and hold down **T7**. While holding **T7** down, depress **T1**. This key combination unlocks the **Field Technician Options** screen.

Press **T6** to navigate to the IO Status screen. Press **T2** to access the Output Status screen. Press  to view additional pages.

**Title:**

n-Controller To i-Controller REV.200 MPU (575V 20-30 Ton) Conversion

### 8.5 Dehumidification Test Mode

From the Main Menu, press and hold down **T7**, while holding **T7** down, depress **T1 (Field Technician Options)**.

From the Field Technician Options screen, press **T2 (Test Modes)**. Press **T3 (2. Operational Tests)**.

Use to navigate to the **Dehumidification Test Mode Off** and press .

When the "OFF" value begins blinking, press the to change the value to "ON", then press .

Wait for **10-minutes**, then terminate Dehumidification.  
*Terminate Dehumidification Test Mode (OFF)*

From the Field Technician Options screen, press **T2 (Test Modes)**. Press **T3 (2. Operational Tests)**.

Use to navigate to the **Dehumidification Test Mode "ON"**, then press .

When the "ON" value begins blinking, press to change the value to "OFF", then press .

Dehumidification mode is now turned "OFF".

### 8.6 Heating Test Mode

From the Field Technician Options screen, press **T2 (Test Modes)**. Press **T3 (2. Operational Tests)**.

Use to navigate to the **Heat Test Mode Off** and press .

When the "OFF" value begins blinking, press the to change the value to "ON" and press .

Wait for **10-minutes**, then terminate Heating.

Terminate **Heating Mode (OFF)**

From the Field Technician Options screen, press **T2 (Test Modes)**. Press **T3 (2. Operational Tests)**.

Use and to navigate to the **Heating Test Mode On** and press .

When the "ON" value begins blinking, press the to change the value to "OFF", then press .

Heating mode is now turned "OFF".

	(A)	(B)	(C)	(D)	(E)	(F)	(G)	(H)	(I)
MODES OF OPERATION	SUPPLY FAN	COMP(S)	COND FAN(S)	RECLAIM	HEATING	OUTDOOR AIR DAMPER	RETURN AIR DAMPER	BYPASS AIR DAMPER	INDICATE PASS or FAIL
DEHUM	ON	ON	ON	N/A	OFF	OPEN*	OPEN**	OPEN	
HEATING	ON	OFF	OFF	N/A	ON	OPEN*	OPEN	OPEN**	
* Damper will be in the OPEN position ( <i>typically 20 - 30% - OPEN 0.5" – 1.50"</i> ).									
** This damper will be OPEN to its minimum position.									

Table 6: Test mode unit status

**Title:**

n-Controller To i-Controller REV.200 MPU (575V 20-30 Ton) Conversion

## 9. BMS Connectivity

The BACnet network connection needs to be established.

By default, the i-Controller BACnet Baud Rate is set to 19.2Kb/s. The MAC address and device number is set to 51. To adjust the address from the Visograph, perform the following steps:

From the **Main Menu**, press **T5**, (**Network Info**). Then, press the **Options** button.

Using the to navigate to the value that you wish to change.

With a field highlighted, press ; the value will begin blinking.

While the highlighted value is blinking, use the , set the value. Press a second time to accept changes.

Once the BACnet address is changed, the controller must be rebooted. Use the or buttons to navigate to the controller reboot option.

Navigate to “Reboot Controller?” and set the value to “YES”. The controller will reboot.

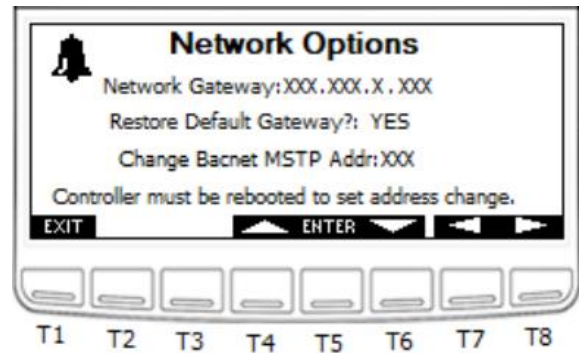

Figure 6. i-Controller Network Information Screen and pin connections

Verify that BACnet is communicating. If it is not communicating, contact the BMS supplier for additional troubleshooting steps.

**Title:** n-Controller To i-Controller REV.200 MPU (575V 20-30 Ton) Conversion

## 10. Appendix:

### 10.1. N-Controller Layout

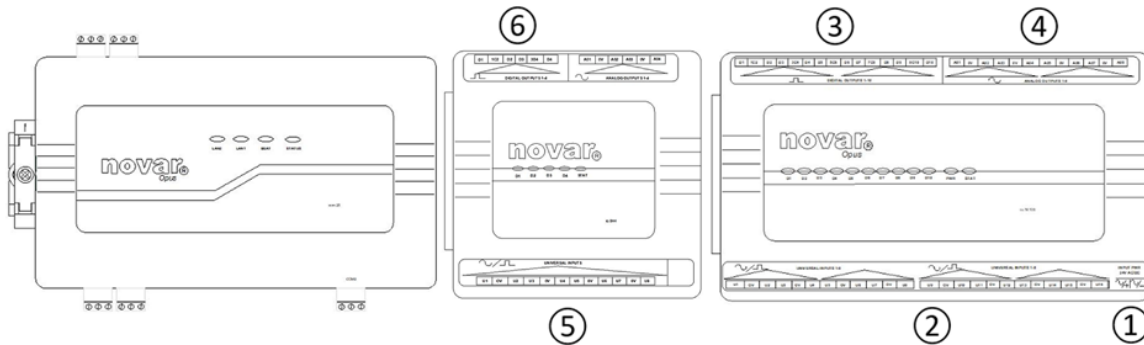

1. 24VAC Power
2. Analog/ Digital Inputs
3. Relay Outputs
4. Analog Outputs
5. Expansion Analog/Digital Inputs
6. Expansion Relay Outputs

### 10.2. i-Controller Layout

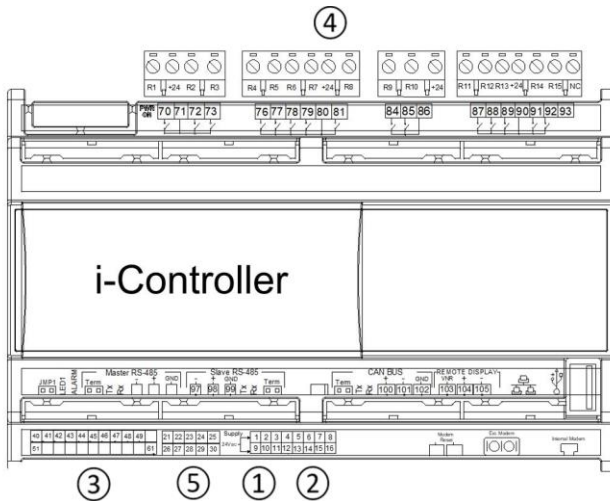

1. 24VAC Power (*Point 9 and 1*)
2. Analog Inputs
3. Digital Inputs
4. Digital Outputs
5. Analog Outputs

### 10.3. Expansion Board Layout



1. Expansion 24VAC Power (*Point 9 and 1*)
2. Expansion A - Analog Inputs
3. Expansion A - Digital Outputs