

Title: (2) 88AO Boards to i-Controller REV.201 WSHP (480V 13-30 Ton) Conversion

Contents

| | | | |
|--|---|--|----|
| 1. Overview | 2 | 9.2 Verify i-Controller Inputs on Visograph..... | 9 |
| 2. Contractor Tools & Materials..... | 2 | 9.3 Calibrate Sensors..... | 9 |
| 3. FLö Supplied Parts..... | 2 | 9.4 Verify i-Controller Outputs..... | 9 |
| 4. Pulling Communications Cable..... | 3 | 9.5 Dehumidification Test Mode..... | 10 |
| 5. Install New Power Supply | 3 | 9.6 Heating Test Mode..... | 10 |
| 5.1 Install New Transformers..... | 3 | 10. BMS Connectivity | 11 |
| 5.2 Wire New Transformers..... | 3 | 11. Appendix: | 12 |
| 5.3 Prepare i-Controller for Installation..... | 3 | 11.1. i-Controller Layout..... | 12 |
| 5.4 Prepare Expansion Module A for Installation | 3 | 11.2. Expansion Board Layout | 12 |
| 5.5 Prepare Expansion Module C for Installation | 3 | | |
| 6. Install New Safety Devices & Sensors | 4 | | |
| 6.1 Digital Phase Monitor Input..... | 4 | | |
| 6.2 Install Refrigerant Pressure Transducers | 4 | | |
| 6.3 Replace Reheat/Reclaim Surface-Mount Probe | 4 | | |
| 6.4 Install Float Switch | 4 | | |
| 6.5 Install New CO2 Sensor | 5 | | |
| 6.6 Install Space Temp/RH Combo Sensor..... | 5 | | |
| 7. Install The i-Controller Components..... | 6 | | |
| 7.1 Remove Existing (2) 88AO Boards..... | 6 | | |
| 7.2 Install New i-Controller and Expansions | 6 | | |
| 7.3 Install Visograph..... | 6 | | |
| 7.4 Connect the i-Controller to Power..... | 6 | | |
| 7.5 Connect the Expansion Modules to Power..... | 6 | | |
| 7.6 Wire Inputs..... | 7 | | |
| 7.7 Wire Analog Output | 8 | | |
| 7.8 Wire Relay Output..... | 8 | | |
| 7.9 Connect Modbus Network..... | 8 | | |
| 8. Validate and Power Up the Unit | 9 | | |
| 8.1 Check Continuity | 9 | | |
| 8.2 Power Up the Unit | 9 | | |
| 8.3 Setting The Digital Phase Monitor (DPM) | 9 | | |
| 9. Test Unit Functionality..... | 9 | | |
| 9.1 Set Time and Date..... | 9 | | |

Title: (2) 88AO Boards to i-Controller REV.201 WSHP (480V 13-30 Ton) Conversion

1. Overview

This document describes the steps required to replace the (2) 88AO Boards with an i-Controller in a 13-30 ton water source heat pump unit.

Below is a brief summary of an i-Controller upgrade.

- Power supply replacement.
- CO2 sensor replacement.
- Pressure transducer installation.
- Reheat/reclaim inlet sensor replacement.
- Space temp/RH sensor replacement.
- Controller replacement.
- Perform operational tests.

2. Contractor Tools & Materials

In addition to a standard toolset, having the items in Table 1 are required during the installation.

| ADDITIONAL TOOLS & MATERIALS | |
|---|---------------------------|
| Cordless Drill | Drill Bit Set |
| Multi-Meter | Adjustable Wrench |
| Wire Strippers | Wire Crimpers |
| Temperature Gauge | Psychrometer |
| Socket Set – Standard | Cell Phone |
| Red Fork Wire Connectors | Fine Point Sharpie Marker |
| 5/16" Self-Tapping Sheetmetal Screws | |
| 18AWG Stranded Insulated Wire (Red, Black & White) | |
| Blue, Orange & Yellow Wire Nuts | |
| Red Insulated Female Spade Connectors | |
| Micro Control Screwdriver Set (Eye Glass Repair Size) | |
| Controls Screwdriver | |
| ½" Step Drill Bit for CO2 Sensor Probe Installation | |
| ¼" Refrigerant Tee with Schrader Depressor & 2 Schrader Cores | |
| 4-Conductor Shielded Twisted Wire or Equivalent | |
| 5-Conductor Shielded Twisted Wire or Equivalent | |
| Modbus Compliant Cable | |

Table 1. Additional Tools & Materials

3. Flō Supplied Parts

The parts contained in the Flō supplied parts kit are provided specifically for the Flō unit at this site.

| Part Description | Part Number | Qty |
|---|---------------|-----|
| i-Controller Unit Controller | PTCS8188101 | 1 |
| i-Controller Expansion Module | PTCS8187001 | 2 |
| DIN-Rail | PTCSP91730 | 3 |
| DIN-Rail End Cap | PTCSV66150 | 6 |
| i-Controller Visograph | PTCS8189002 | 1 |
| Visograph/CO2 Sensor Mounting Bracket | PTCS184068001 | 2 |
| 24VAC Isolated Transformer | PTCSR75280 | 2 |
| 4-Wire Duct CO2 Sensor (with Tubing and Duct Probe) | PTCSV57760 | 1 |
| Pressure Transducer (0-500psi) | PTCSV67380 | 2 |
| Transducer Whip (Blue) | PTCSV42220 | 2 |
| Pressure Transducer (0-667psi) | PTCSV67390 | 2 |
| Transducer Whip (Yellow) | PTCSV42100 | 2 |
| Temperature/Humidity Combo Sensor ** | PTCS2035752 | 1 |
| Reheat/Reclaim Coil Surface Mount Temp Sensor | PTCS5011125 | 1 |
| Float Switch Kit | PTCSS25801 | 1 |
| Upgrade Document | IN-IC1-18 | 1 |

Table 2. Flō Supplied Parts List

****NOTE:** PTCS2035752 may be substituted for a RH Sensor (PTCS2035751) and a Temp Probe (PTCS5011121).

Title:

(2) 88AO Boards to i-Controller REV.201 WSHP (480V 13-30 Ton) Conversion

4. Pulling Communications Cable

A Modbus communications cable must be pulled to the unit for communication to the BMS system.

5. Install New Power Supply

CAUTION: Make sure the power to the FLō unit is turned off and internal electrical circuits are NOT energized.

5.1 Install New Transformers

Using 5/16" screws, mount the 2 transformers in an area that has available space inside the controls cabinet.

Using the sharpie, mark the transformers as #1 and #2. Transformer 1 will be dedicated to powering the i-controller. Transformer 2 will be dedicated to powering all expansion modules.

NOTE: No other devices will be connected to these transformers.

5.2 Wire New Transformers

Run the new transformers' high voltage wires to FLō high voltage terminals L1 and L2.

NOTE: Ensure the transformer tap correlates to the unit's high voltage.

Leave the new transformers' low voltage wires disconnected. These will be terminated in the next steps.

5.3 Prepare i-Controller for Installation

Attach 10" lengths of Black 18 AWG wire to the following i-Controller green plug connection points: 1, 7, 8, 25, 28 & 61. See Figure 1. for plug orientation.

Attach 10" lengths of Red 18 AWG wire to the following i-Controller green plug connection points: 9, 15, 16, 29 & 71. See Figure 1. for plug orientation.



Figure 1. Green Connector Reference

Attach Red 18 AWG jumper wires between the following points on the i-Controller green plug connection points: 71 to 80, 80 to 86, and 86 to 90.

Attach a new Black 18 AWG wire between the FLō unit's CSTB1 24 VAC- (grounded side) and the Black 18 AWG wire coming from point 61 on the i-Controller.

Attach a new Red 18 AWG wire between the FLō unit's CSTB1 24 VAC+ (hot side) and the Red 18 AWG wire coming from point 71 on the i-Controller.

5.4 Prepare Expansion Module A for Installation

Attach 10" lengths of Black 18 AWG wire to the following Expansion green plug connection points: 1 & 15**.

****NOTE:** Only pigtail 15 if the unit has a CO2 or outdoor humidity sensor.

Attach a 10" length of Red 18 AWG wire to the following Expansion green plug connection point: 9.

5.5 Prepare Expansion Module C for Installation

Attach 10" lengths of Black 18 AWG wire to the following Expansion green plug connection points: 1, 13, 14 & 20.

Attach a 10" length of Red 18 AWG wire to the following Expansion green plug connection point: 9.

Title: (2) 88AO Boards to i-Controller REV.201 WSHP (480V 13-30 Ton) Conversion

6. Install New Safety Devices & Sensors

6.1 Digital Phase Monitor Input

Pull a 2-conductor cable from the DPM to the future i-Controller location in the electrical cabinet. Connect wire at DPM to Auxiliary contact points.

6.2 Install Refrigerant Pressure Transducers

Remove existing suction transducers from circuits 1&2. Discard this transducers and cables.

Install the 0-500 PSI Suction transducers on the suction lines of circuits 1 & 2. Install the 0-667 PSI Discharge transducers on the liquid lines of circuits 1 & 2. If there are spare service ports on the unit, install the transducers on a spare service port. If spare service ports are not available, use a refrigerant tee.

Using the provided transducer whips, plug the blue whips into the new suction transducers and the yellow whips into the new discharge transducers. Run the whips back to the future i-Controller location in the electrical cabinet.

6.3 Replace Reheat/Reclaim Surface-Mount Probe

If there is a temperature probe currently on the Reheat/Reclaim inlet pipe, remove and discard probe and cable. Secure and insulate the new temperature probe on the inlet piping of the reheat/reclaim coil. Run cable back to the future i-Controller location in the electrical cabinet.

6.4 Install Float Switch

Connect the float switch to the provided bracket using the provided washer and nut.

Mount the provided bracket so that the base of the bracket is roughly 2 inches from the drain pan base and located at the front left corner of the drain pan, on the supply fan wall (see figure 2 for positioning requirements)



Figure 2. Float Switch Mounting Position

Pull a 2-conductor cable to the electrical cabinet.

Title: (2) 88AO Boards to i-Controller REV.201 WSHP (480V 13-30 Ton) Conversion

6.5 Install New CO2 Sensor

Locate and unfasten the old CO2 sensor. It is located on a column in the store or in the return section of the FLō unit.

Pull a new 4-conductor cable to the return section of the FLō unit. Fasten the new bracket and new sensor to the unit above the outdoor air damper opening on the right-hand side (see figure 3, upper arrow).

Locate the dip switches inside of the new CO2 sensor and change dip switch 1 from 10 VDC to 5 VDC.

Drill a 1/2" hole in the return damper housing and mount the probe (see figure 3, lower arrow).

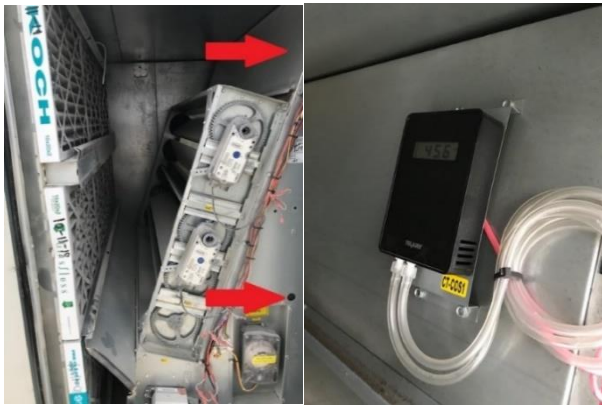

Figure 3. CO2 sensor location inside the unit

Wire the new CO2 based on the following (see Figure 4.):

- +24VAC – Red wire
- -24VAC – Black wire
- COM – Green wire
- CO2 SIGNAL – White wire

NOTE: Do not wire the CO2 sensor to the i-Controller or Expansion Module at this time.

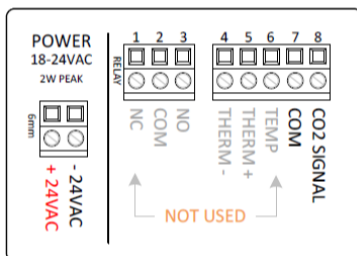

Figure 4. CO2 Sensor Wiring

6.6 Install Space Temp/RH Combo Sensor

Replace the current space temp/RH sensors in the space with a new combo sensor (203-5752) provided with this kit.

NOTE: If necessary, pull a new 5-wire conductor cable.

Mount the base of the new space temp/RH combo sensor in the place where the old sensor was located.

Wire the new combo sensor based on the following (see figure 5.):

- +12VDC – Red wire
- 0V (on Humidity side) – Black wire
- RH OUT (+0-5V) – White wire
- 0V (on Temp side) – Green wire
- SIGNAL – Blue wire

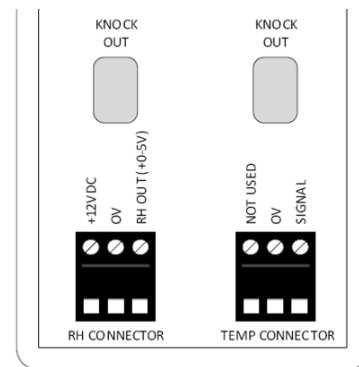

Figure 5.1. 203-5752 Space Temp/Humidity Terminal Connections

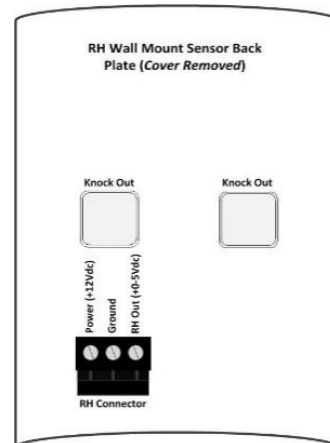

Figure 5.2. 203-5751 Humidity Terminal Connections

Title: (2) 88AO Boards to i-Controller REV.201 WSHP (480V 13-30 Ton) Conversion



Figure 5.3. 501-1125 Temp Sensor Mounting Position In RH

IMPORTANT: If you have a 203-5752, move the jumper on JP3 from 10V to 5V on the combo sensor.

NOTE: Do not wire the combo sensor to the i-Controller or Expansion Module at this time.

7. Install The i-Controller Components

7.1 Remove Existing (2) 88AO Boards

Locate and remove the (2) 88AO Boards.

NOTE: If the (2) 88AO Boards inputs and outputs are not labeled, label these wires before proceeding.

7.2 Install New i-Controller and Expansions

Mount the i-Controller and expansion modules on DIN rails.

Double-check that the Expansion Modules are addressed as 1&3. Verify the addressing and adjust as necessary on the dip switches (location called out in *Figure 6*. This figure is an example of expansion A setup).

Expansion A (#1) – 1 up, 2 down, 3 down, 4 down
 Expansion C (#3)– 1 up, 2 up, 3 down, 4 down

NOTE: The actual switch may be white but for illustrative purposes, the switch is black in the *Figure 6* below.

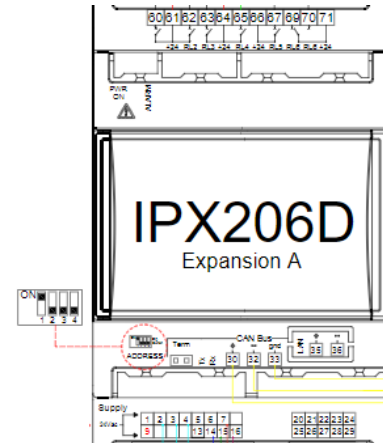

Figure 6. Flō i-Controller Expansion Addressing

Wire the 2 expansion modules to the main i-Controller via the **CAN Bus** port in a daisy change based on the following:

- Expansion Module (C) 30 (+) → Expansion Module (A) 30 (+) → i-Controller 100 (+)
- Expansion Module (C) 32 (-) → Expansion Module (A) 32 (-) → i-Controller 101 (-)
- Expansion Module (C) 33 (gnd) → Expansion Module (A) 33 (gnd) → i-Controller 102 (gnd)

7.3 Install Visograph

Mount the Visograph and connect it to the i-Controller port.

Wire the Visograph based on the following:

- White wire VNR (Visograph) → 103 (i-Controller)
- Red wire + (Visograph) → 104 (i-Controller)
- Black wire – (Visograph) → 105 (i-Controller)

7.4 Connect the i-Controller to Power

Connect transformer 1’s low voltage common to black 10” wire from i-Controller pin 1.

Connect transformer 1’s low voltage 24V to red 10” wire from i-Controller pin 9.

7.5 Connect the Expansion Modules to Power

Connect transformer 2’s low voltage common to black 10” wire from both expansion modules pin 1.

Connect transformer 2’s low voltage 24V to red 10” wire from both expansion modules pin 9.

Title:

(2) 88AO Boards to i-Controller REV.201 WSHP (480V 13-30 Ton) Conversion

7.6 Wire Inputs

Wire analog/digital inputs based on table 3.

| Existing Points | i-Controller | i-Controller Pin # |
|----------------------------|---------------------------------|-----------------------|
| NEW | 24 VAC Transformer Power 1 - | 1* |
| | 24 VAC Transformer Power 1 + | 9* |
| | Space Temperature 1 SG | 2 |
| | Space Temperature 1 0V | 7* |
| | Space Humidity 1 SG | 3 |
| | Space Humidity 1 0V | 8* |
| | Space Humidity 1 Power | 16* |
| | See Wiring Diagram in Unit | Supply Temperature SG |
| Supply Temperature 0V | | 7* |
| NEW | Reheat/Reclaim Inlet Probe 1 SG | 5 |
| | Reheat/Reclaim Inlet Probe 1 0V | 7* |
| See Wiring Diagram in Unit | Outside Air Temperature SG | 6 |
| | Outside Air Temperature 0V | 7* |
| | Return Temperature SG | 10 |
| | Return Temperature 0V | 7* |
| NEW | Suction Press Comp 1 SG WHT | 11 |
| | Suction Press Comp 1 0V BLK | 8* |
| | Suction Press Comp 1 Pwr RED | 15* |
| | Discharge Press Comp 1 SG WHT | 12 |
| | Discharge Press Comp 1 0V BLK | 8* |
| | Discharge Press Comp 1 Pwr RED | 15* |
| | Suction Press Comp 2 SG WHT | 13 |
| | Suction Press Comp 2 0V BLK | 8* |
| | Suction Press Comp 2 Pwr RED | 15* |
| | Discharge Press Comp 2 SG WHT | 14 |
| | Discharge Press Comp 2 0V BLK | 8* |
| | Discharge Press Comp 2 Pwr RED | 15* |

| Existing Points | i-Controller | i-Controller Pin # |
|----------------------------|---------------------------------------|---------------------------|
| See Wiring Diagram in Unit | Smoke Detector/ Emergency Shutdown SG | 40 |
| | Smoke Detector/ Emergency Shutdown 0V | 61* |
| | Airflow Switch SG | 41 |
| | Airflow Switch 0V | 61* |
| | Clogged Filter SG | 42 |
| | Clogged Filter 0V | 61* |
| | Load Shed SG (if equipped) | 45 |
| | Load Shed 0V (if equipped) | 61* |
| | NEW | Drain Pan Float Switch SG |
| Drain Pan Float Switch 0V | | 61* |
| Phase Monitor SG | | 44 |
| Phase Monitor 0V | | 61* |

| Existing Points | Expansion Module A | Expansion A Pin # |
|--------------------------------------|------------------------------|-----------------------------------|
| NEW | 24 VAC Transformer Power 2 - | 1* |
| | 24 VAC Transformer Power 2 + | 9* |
| | CO2 SG (if equipped) | 2 |
| | CO2 0V (if equipped) | 15* |
| | CO2 +24 (if equipped) | CSTB1 Red** |
| | CO2 -24 (if equipped) | CSTB1 Black** |
| | See Wiring Diagram in Unit | Outdoor Humidity SG (if equipped) |
| Outdoor Humidity 0V (if equipped) | | 15* |
| Outdoor Humidity Power (if equipped) | | 7 |

Title: (2) 88AO Boards to i-Controller REV.201 WSHP (480V 13-30 Ton) Conversion

| Existing Points | Expansion Module C | Expansion C Pin # |
|----------------------------|------------------------------|-------------------|
| NEW | 24 VAC Transformer Power 2 - | 1* |
| | 24 VAC Transformer Power 2 + | 9* |
| See Wiring Diagram in Unit | Entering Condenser Temp A SG | 2 |
| | Entering Condenser Temp A 0V | 14* |
| | Leaving Condenser Temp A SG | 3 |
| | Leaving Condenser Temp A 0V | 14* |
| | Condenser Flow Proof A SG | 10 |
| | Condenser Flow Proof A 0V | 13* |

*This indicates that you will be attaching to a 10" wire, not a pin.

**This indicates that you will be attaching to the CSTB1.

Table 3. Input Conversion Table

7.7 Wire Analog Output

Wire analog outputs based on table 4.

| Existing Points | i-Controller | i-Controller Pin # |
|----------------------------|-------------------------|--------------------|
| See Wiring Diagram in Unit | Outside Air Damper SG | 21 |
| | Outside Air Damper 0V | 25* |
| | Return Air Damper SG | 22 |
| | Return Air Damper 0V | 25* |
| | Bypass Air Damper SG | 23 |
| | Bypass Air Damper 0V | 25* |
| | VFD SG | 24 |
| | VFD 0V | 25* |
| | Digital Compressor 1 SG | 26 |
| | Digital Compressor 1 0V | 25* |
| | Modulated Reheat SG | 27 |
| | Modulated Reheat 0V | 25* |
| New | CSTB -24VAC Black | 28* |
| | CSTB +24VAC Red | 29* |

| Existing Points | Expansion Module C | Expansion C Pin # |
|----------------------------|----------------------|-------------------|
| See Wiring Diagram in Unit | Condenser Valve A SG | 21 |
| | Condenser Valve A 0V | 20* |

*This indicates that you will be attaching to a 10" wire, not a pin. If multiple CSTB's, use the CSTB that powers the actuators.

Table 4. Analog Output Conversion Table

7.8 Wire Relay Output

Wire relay outputs based on table 5.

| Existing Points | i-Controller | i-Controller Pin # |
|----------------------------|--|--------------------|
| See Wiring Diagram in Unit | Supply Fan 1 (NO) | 70 |
| | Heat Stage 1/Modulating Heat Enable (NO) | 72 |
| | Heat Stage 2 (NO) | 73* |
| | Heat Stage 3 (NO) | 76* |
| | Heat Stage 4 (NO) | 77* |
| | Compressor 2 (NO) | 78 |
| | Reheat/Heat Reclaim 1 (NO) | 84 |
| | CSTB1 +24VAC | 71, 80, 86**, 90 |

*if equipped

****WARNING:** For units equipped with refrigerant reclaim, do not wire +24VAC to point 86. The dry common from the refrigeration rack reclaim control is connected to point 86.

| Existing Points | Expansion Module A | Expansion A Pin # |
|----------------------------|---|-------------------|
| See Wiring Diagram in Unit | ERV Wheel (if applicable) | 60 |
| | Power Exhaust (if applicable) | 62 |
| | CSTB1 +24VAC (if applicable with ERV Wheel) | 61 |

| Existing Points | Expansion Module C | Expansion C Pin # |
|----------------------------|--------------------|-------------------|
| See Wiring Diagram in Unit | Reversing Valves | 60 |
| | CSTB1 +24VAC | 61 |

Table 5. Digital Output Conversion Table

7.9 Connect Modbus Network

Wire BACnet based on the following:

- Black wire RS485 Slave – → 97 (i-Controller)
- White wire RS485 Slave + → 98 (i-Controller)
- Shield wire RS485 Slave GND → 99 (i-Controller)

Title: (2) 88AO Boards to i-Controller REV.201 WSHP (480V 13-30 Ton) Conversion

8. Validate and Power Up the Unit

8.1 Check Continuity

Once all connections are complete, using a multimeter, verify points 1, 7, and 8 are not reading to earth ground.

Now check for shorts within the analog sensor connections by measuring between points 7 and 8.

If you have any issues, please call FLō tech support at 1-888-598-1198.

8.2 Power Up the Unit

Turn on the unit disconnect and wait for the i-Controller screen to display "CES".

8.3 Setting The Digital Phase Monitor (DPM)

Set the DPM to the following values:

1. Line Voltage = Set to FLō name plate voltage
2. Over/Under % = Set to 10%
3. Trip Delay = 5 Seconds
4. Restart Delay = 2 Minutes
5. Phase Imbalance = 5%

9. Test Unit Functionality



Figure 7 Visograph Button designation

9.1 Set Time and Date

From the **Main Menu**, press **T5**, (**Network Info**).

Press and verify the time is correct. If the correct time is not displayed, set the time.

Use the to navigate to the hour or minute fields.

With a field highlighted, press ; the value will begin blinking.

While the highlighted value is blinking, use the and set the value. Press a second time to accept changes.

The controller will automatically reboot after the date and or time has been changed.

9.2 Verify i-Controller Inputs on Visograph

Verify all installed sensors are present and displaying accurate values.

From the **Main Menu**, press and hold down **T7**. While holding **T7** down, depress **T1**. This key combination unlocks the **Field Technician Options** screen.

Press **T6** to navigate to the IO Status screen. Press **T2** to access the **Input Status** screen. Press to view additional pages.

9.3 Calibrate Sensors

From the **Main Menu**, press and hold down **T7**. While holding **T7** down, depress **T1**. This key combination unlocks the **Field Technician Options** screen.

Press **T1** to navigate to the IO Status screen.

Press to view additional pages.

Enter the offset(s) as necessary. Do not exceed $\pm 3^{\circ}\text{F}$ for a temperature sensor, $\pm 2^{\circ}\text{F}$ for a dewpoint sensor or $\pm 3\%$ for a humidity sensor.

9.4 Verify i-Controller Outputs

From the **Main Menu**, press and hold down **T7**. While holding **T7** down, depress **T1**. This key combination unlocks the **Field Technician Options** screen.

Press **T6** to navigate to the IO Status screen. Press **T3** to access the **Output Status** screen. Press to view additional pages.

Title: (2) 88AO Boards to i-Controller REV.201 WSHP (480V 13-30 Ton) Conversion

9.5 Dehumidification Test Mode

From the Main Menu, press and hold down **T7**, while holding **T7** down, depress **T1 (Field Technician Options)**.

From the Field Technician Options screen, press **T2 (Test Modes)**. Press **T3 (2. Operational Tests)**.

Use to navigate to the **Dehumidification Test Mode Off** and press .

When the "OFF" value begins blinking, press the to change the value to "ON", then press .

Wait for **10-minutes**, then terminate Dehumidification.
Terminate Dehumidification Test Mode (OFF)

From the Field Technician Options screen, press **T2 (Test Modes)**. Press **T3 (2. Operational Tests)**.

Use to navigate to the **Dehumidification Test Mode "ON"**, then press .

When the "ON" value begins blinking, press to change the value to "OFF", then press .

Dehumidification mode is now turned "OFF".

9.6 Heating Test Mode

From the Field Technician Options screen, press **T2 (Test Modes)**. Press **T3 (2. Operational Tests)**.

Use to navigate to the **Heat Test Mode Off** and press .

When the "OFF" value begins blinking, press the to change the value to "ON" and press .

Wait for **10-minutes**, then terminate Heating.

Terminate **Heating Mode (OFF)**

From the Field Technician Options screen, press **T2 (Test Modes)**. Press **T3 (2. Operational Tests)**.

Use and to navigate to the **Heating Test Mode On** and press .

When the "ON" value begins blinking, press the to change the value to "OFF", then press .

Heating mode is now turned "OFF".

| | (A) | (B) | (C) | (D) | (E) | (F) | (G) | (H) | (I) |
|--|------------|---------|-------------|---------|---------|--------------------|-------------------|-------------------|-----------------------|
| MODES OF OPERATION | SUPPLY FAN | COMP(S) | COND FAN(S) | RECLAIM | HEATING | OUTDOOR AIR DAMPER | RETURN AIR DAMPER | BYPASS AIR DAMPER | INDICATE PASS or FAIL |
| DEHUM | ON | ON | ON | N/A | OFF | OPEN* | OPEN** | OPEN | |
| HEATING | ON | OFF | OFF | N/A | ON | OPEN* | OPEN | OPEN** | |
| * Damper will be in the OPEN position (<i>typically 20 - 30% - OPEN 0.5" – 1.50"</i>). | | | | | | | | | |
| ** This damper will be OPEN to its minimum position. | | | | | | | | | |

Table 6: Test mode unit status

Title: (2) 88AO Boards to i-Controller REV.201 WSHP (480V 13-30 Ton) Conversion

10. BMS Connectivity

The Modbus network connection needs to be established.

NOTE: Ensure the BMS is setup with proper licensing, integration files, etc. for the i-Controller before testing communication.

By default, the i-Controller Modbus Baud Rate is set to 19.2Kb/s. The Modbus address is set to 1. To adjust the address from the Visograph, perform the following steps:

From the **Main Menu**, press **T5**, (**Network Info**). Then, press the **Options** button.

Using the to navigate to the value that you wish to change.

With a field highlighted, press ; the value will begin blinking.

While the highlighted value is blinking, use the , set the value. Press a second time to accept changes.

Once the Modbus address is changed, the controller must be rebooted. Use the or buttons to navigate to the controller reboot option.

Navigate to “Reboot Controller?” and set the value to “YES”. The controller will reboot.

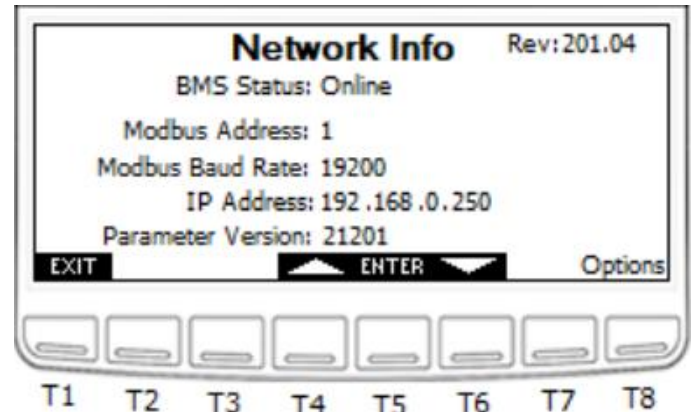

Figure 8. i-Controller Network Information Screen and pin connections

Verify that Modbus is communicating. If it is not communicating, contact the BMS supplier for additional troubleshooting steps.

Title: (2) 88AO Boards to i-Controller REV.201 WSHP (480V 13-30 Ton) Conversion

11. Appendix:

11.1. i-Controller Layout

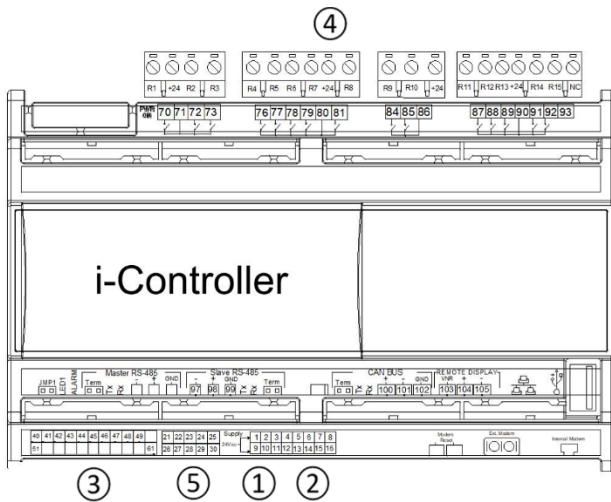

1. 24VAC Power (Point 9 and 1)
2. Analog Inputs
3. Digital Inputs
4. Digital Outputs
5. Analog Outputs

11.2. Expansion Board Layout



1. Expansion 24VAC Power (Point 9 and 1)
2. Expansion Analog Inputs
3. Expansion Digital Outputs